

## YO 1000 - Газовая пружина

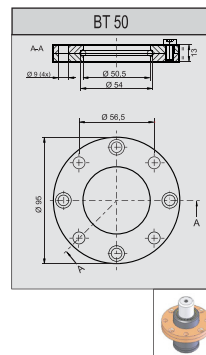

Давление газа : Nitrogen N2  
 Макс. Давление : 150 bar  
 Мин. Давление : 25 bar  
 Рабочая Темп. : 0°C ve +80°CMax  
 Рабочая скорость : 1,8 m / s

Apr.	Kurs	L	Lmin	daN	Kg	Alt Görünüm
YO-100010	10	58	48	1000	- 0,57	
YO-100013	13	64	51		- 0,59	
YO-100016	16	70	54		- 0,62	
YO-100019	19	76	57		- 0,65	
YO-100025	25	88	63		- 0,70	
YO-100032	32	102	70		- 0,77	
YO-100038	38	114	76		- 0,83	
YO-100050	50	138	88		- 0,94	
YO-100063	63	164	101		- 1,07	
YO-100075	75	188	113		- 1,16	
YO-100080	80	198	118		- 1,21	
YO-1000100	100	238	138		- 1,43	
YO-1000125	125	288	163	- 1,70		

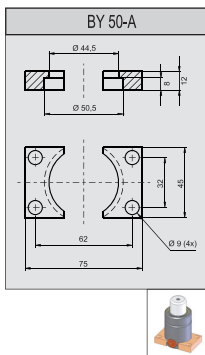
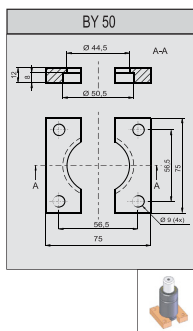
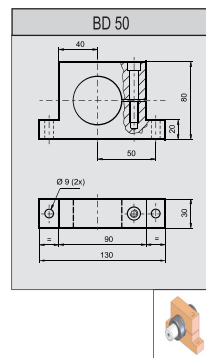
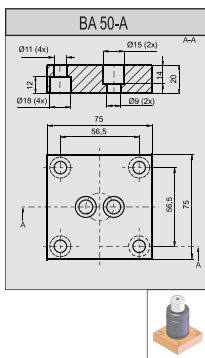
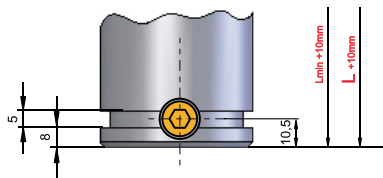
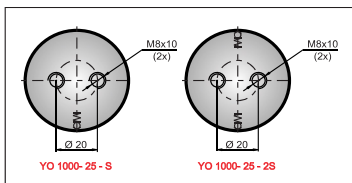

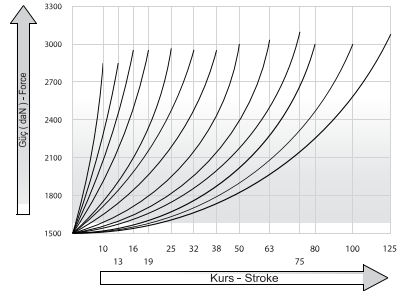
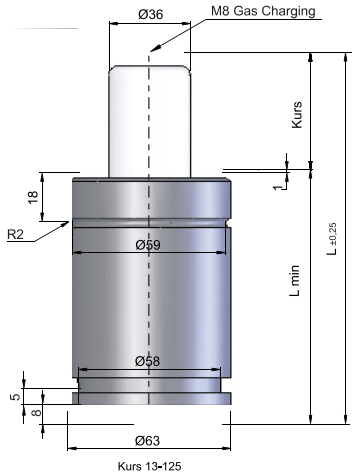

Apr.	Kurs	L	Lmin	daN	Kg	Alt Görünüm
YO-150010	10	64	54	1500	- 1,02	
YO-150013	13	70	57		- 1,05	
YO-150016	16	76	60		- 1,10	
YO-150019	19	82	63		- 1,15	
YO-150025	25	94	69		- 1,25	
YO-150032	32	108	76		- 1,35	
YO-150038	38	120	82		- 1,44	
YO-150050	50	144	94		- 1,61	
YO-150063	63	170	107		- 1,81	
YO-150075	75	194	119		- 1,90	
YO-150080	80	204	124		- 2,06	
YO-1500100	100	244	144		- 2,38	
YO-1500125	125	294	169	- 2,86		

## YO 1500 - Газовая пружина



Давление газа : Nitrogen N2  
 Макс. Давление : 150 bar  
 Мин. Давление : 25 bar  
 Рабочая Темп. : 0°C ve +80°CMax  
 Рабочая скорость : 1,8 m / s

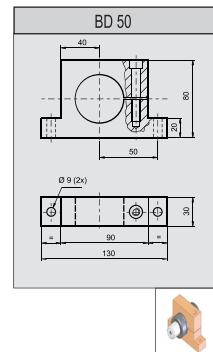
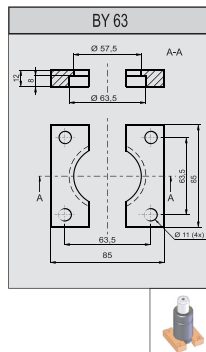
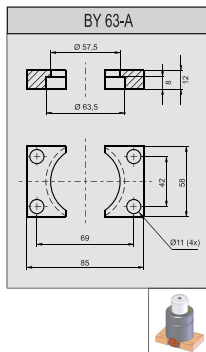
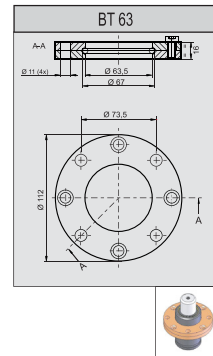
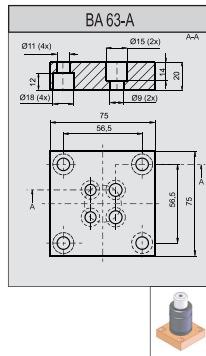
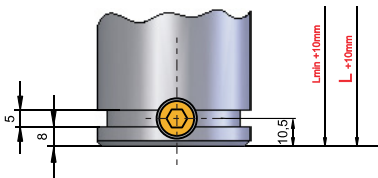
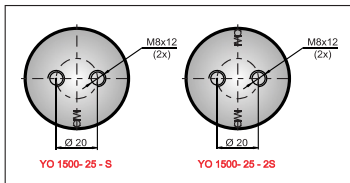



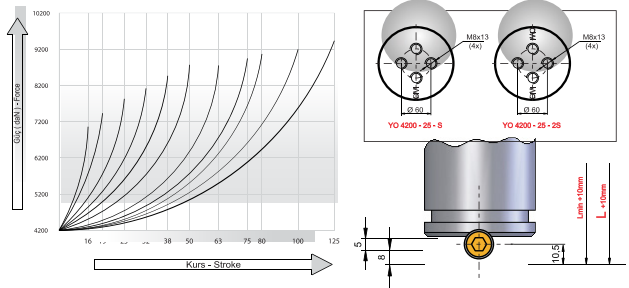
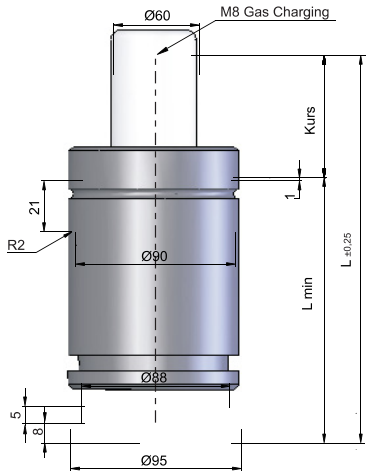

## YO 4200 - Газовая пружина

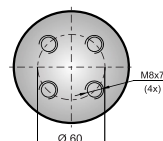

Давление газа : Nitrogen N2  
 Макс. Давление : 150 bar  
 Мин. Давление : 25 bar  
 Рабочая Темп. : 0°C ve +80°CMax  
 Рабочая скорость : 1,8 m / s

Art.	Kurs	L	Lmin	daN	Kg	Alt Görünüm
YO-420016	16	97	81	4200	~ 3,40	
YO-420019	19	103	84		~ 3,45	
YO-420025	25	115	90		~ 3,65	
YO-420032	32	129	97		~ 3,82	
YO-420038	38	141	103		~ 4,00	
YO-420050	50	165	115		~ 4,44	
YO-420063	63	191	128		~ 4,95	
YO-420075	75	215	140		~ 5,20	
YO-420080	80	225	145		~ 5,41	
YO-4200100	100	265	165		~ 6,00	
YO-4200125	125	315	190		~ 6,70	

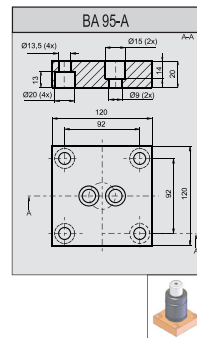
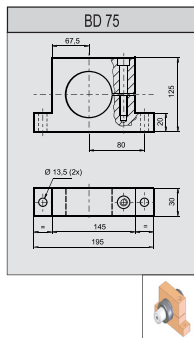
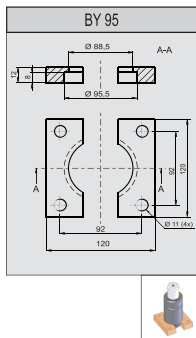
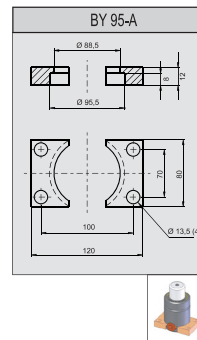
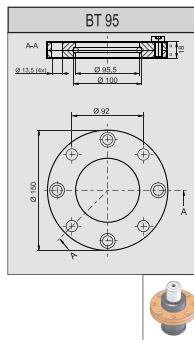
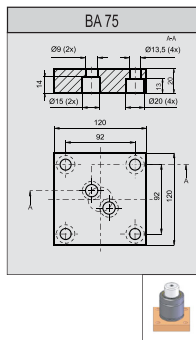

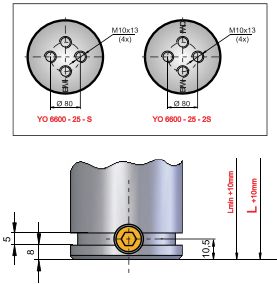
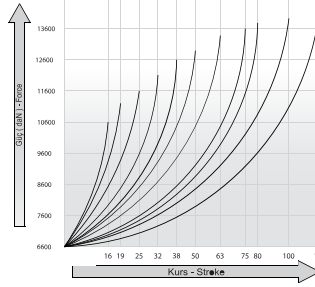
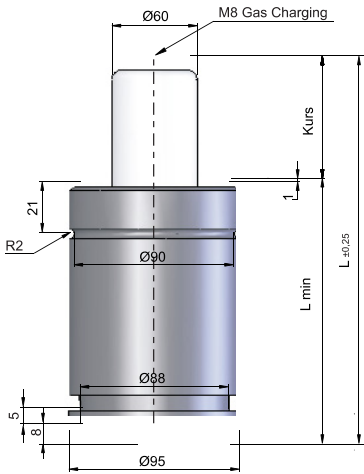

## YO 6600 - Газовая пружина



Давление газа : Nitrogen N2  
 Макс. Давление : 150 bar  
 Мин. Давление : 25 bar  
 Рабочая Темп. : 0°C ve +80°CMax  
 Рабочая скорость : 1,8 m / s

Art.	Kurs	L	Lmin	daN	Kg	Alt Görünüm
YO-660016	16	107	91	6600	~ 6,60	
YO-660019	19	113	94		~ 6,65	
YO-660025	25	125	100		~ 6,82	
YO-660032	32	139	107		~ 7,18	
YO-660038	38	151	113		~ 7,57	
YO-660050	50	175	125		~ 8,18	
YO-660063	63	201	138		~ 8,81	
YO-660075	75	225	150		~ 8,95	
YO-660080	80	235	155		~ 9,10	
YO-660100	100	275	175		~ 10,7	
YO-660125	125	325	200		~ 12,5	

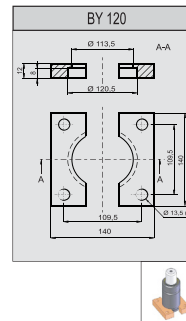
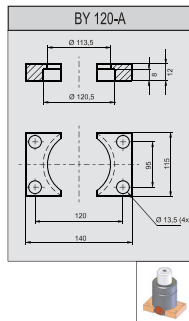
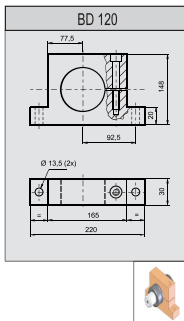
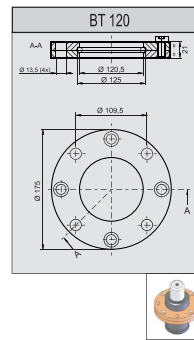
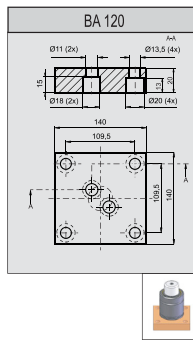
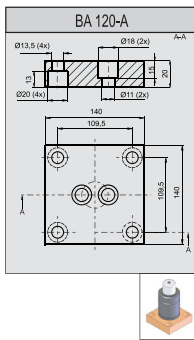



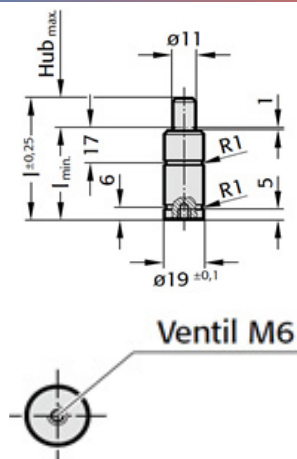

**MG 170 - Газовая пружина**

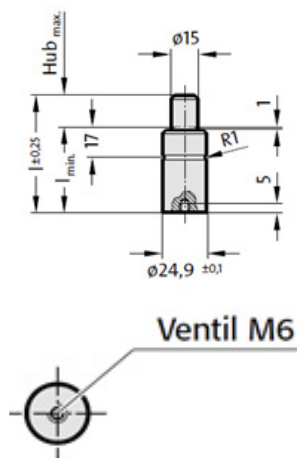
Арт.	Курс	Курс	L	İlk Kuvvet	Son Kuvvet	kg
MG-1707	7	37	44	170 KG	280 KG	0,06
MG-17010	10	40	50			0,06
MG-17015	15	45	60			0,07
MG-17019	19	49	68			0,07
MG-17025	25	55	80			0,08
MG-17038	38	68	106			0,09
MG-17050	50	80	130			0,10
MG-17063	63	93	156			0,12
MG-17075	75	110	185			0,14
MG-17080	80	115	195			0,14
MG-170100	100	135	235			0,17
MG-170125	125	160	285			0,19

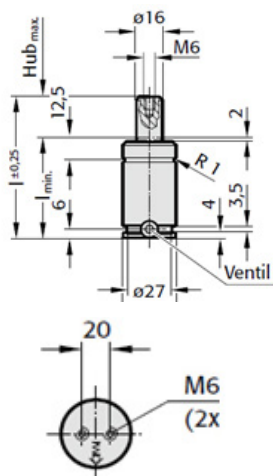

**MG 320 - Газовая пружина**

Арт.	Курс	Курс	L	İlk Kuvvet	Son Kuvvet	kg
MG-3207	7	37	44	320 KG	520 KG	0,10
MG-32010	10	40	50			0,10
MG-32015	15	45	60			0,11
MG-32019	19	49	68			0,12
MG-32025	25	55	80			0,13
MG-32032	32	62	94			0,14
MG-32038	38	68	106			0,15
MG-32050	50	80	130			0,17
MG-32063	63	93	156			0,19
MG-32075	75	110	185			0,22
MG-32080	80	115	195			0,23
MG-320100	100	135	235			0,26
MG-320125	125	160	285			0,30

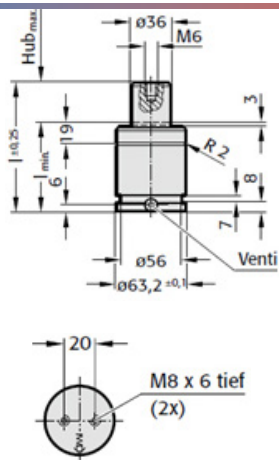

**MG 350 - Газовая пружина**

Арт.	Курс	Курс	L	İlk Kuvvet	Son Kuvvet	kg
MG-35010	10	40	50	350 KG	540 KG	0,16
MG-35013	13	43	56			0,17
MG-35016	16	46	62			0,18
MG-35019	19	49	68			0,19
MG-35025	25	55	80			0,21
MG-35032	32	62	94			0,23
MG-35038	38	68	106			0,25
MG-35050	50	80	130			0,29
MG-35063	63	93	156			0,33
MG-35075	75	105	180			0,36
MG-35080	80	110	190			0,38
MG-350100	100	130	230			0,44
MG-350125	125	155	280			0,51



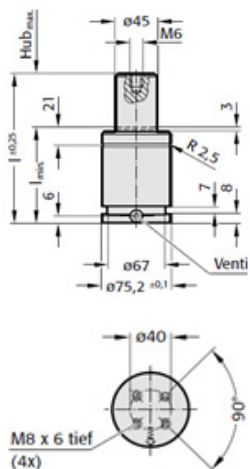

**MG 1500 - Газовая пружина**

Арт.	Курс	Курс	L	İlk Kuvvet	Son Kuvvet	kg
MG-150013	13	57	70	1500 KG	2400 KG	0,92
MG-150016	16	60	76			0,96
MG-150019	19	63	82			0,99
MG-150025	25	69	94			1,06
MG-150032	32	76	108			1,14
MG-150038	38	82	120			1,21
MG-150050	50	94	144			1,35
MG-150063	63	107	170			1,51
MG-150075	75	119	194			1,65
MG-150080	80	124	204			1,71
MG-1500100	100	144	244			1,94
MG-1500125	125	169	294			2,23

**MG 2400 - Газовая пружина**

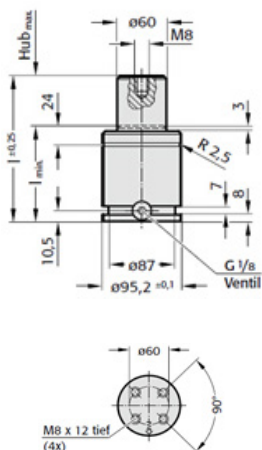
Арт.	Курс	Курс	L	İlk Kuvvet	Son Kuvvet	kg
MG-240016	16	61	77	2400 KG	3840 KG	1,36
MG-240019	19	64	83			1,40
MG-240025	25	70	95			1,50
MG-240032	32	77	109			1,61
MG-240038	38	83	121			1,70
MG-240050	50	95	145			1,89
MG-240063	63	108	171			2,09
MG-240075	75	120	195			2,28
MG-240080	80	125	205			2,36
MG-2400100	100	145	245			2,67
MG-2400125	125	170	295			3,07

**MG 4200 - Газовая пружина**

Арт.	Курс	Курс	L	İlk Kuvvet	Son Kuvvet	kg
MG-420016	16	74	90	4200 KG	6700 KG	2,76
MG-420019	19	77	96			2,83
MG-420025	25	83	108			2,98
MG-420032	32	90	122			3,16
MG-420038	38	96	134			3,30
MG-420050	50	108	158			3,60
MG-420063	63	121	184			3,93
MG-420075	75	133	208			4,20
MG-420080	80	138	218			4,35
MG-4200100	100	158	258			4,85
MG-4200125	125	183	308			5,47

